

	HF2 PACKAGES	HF2 BT80-A	HF2 BT125-A
Binocular Telescope OTA	Objective Elements (Achromatic)	Air-spaced doublet (Built-in extender lens)	Air-spaced doublet (Built-in extender lens)
	Lens Coatings	Magnesium fluoride single layer	Multi-coated
	Effective Aperture	80mm	125mm
	Focal Length	900mm	760mm
	Focal Ratio	1 : 11.2	1 : 6.08
	Light Gathering Power	131x	319x
	Resolution	1.45	0.93
	Limiting Magnitude	11.3	12.3
	Dimensions	58cm x 19cm x 21.5cm (22.8" x 7.5" x 8.5")	63cm x 36cm x 23cm (24.8" x 14.2" x 9.1")
	Weight	5 Kgs (11 lbs.)	10.9 kgs (24 lbs.)
Mount	Visual Back	31.7mm Push-fit (1.25")	31.7mm Push-fit (1.25")
	Eyepiece - 31.7mm size (Magnification, Field of view)	NLV25mm x 2, <Your package may differ.> (36x, 1.38 degrees)	NLV25mm x 2, <Your package may differ.> (30x, 1.66 degrees)
	Type of Mount	Alt-Azimuth fork mount	Alt-Azimuth fork mount
Tipod Others	Vertical and Horizontal Movements	Friction control system	Friction control system
	Weight	3.4 kgs approx. (7.48 lbs.)	3.4 kgs approx. (7.48 lbs.)
	Tripod Legs	Aluminum two-section leg with quick brace	Aluminum two-section leg with quick brace
Tipod Others	Adjustable Length, Weight	90cm to 130cm in length, 5.5 kgs	90cm to 130cm in length, 5.5 kgs
	Accessory	Swing Bracket, Carry handle	Carry handle, Finder bracket base
	Total Weight of the Package	15 kgs <without eyepieces>, (33 lbs.)	19.8 kgs <without eyepieces>, (43.6 lbs.)

## HF2 ALT-AZIMUTH FORK MOUNT

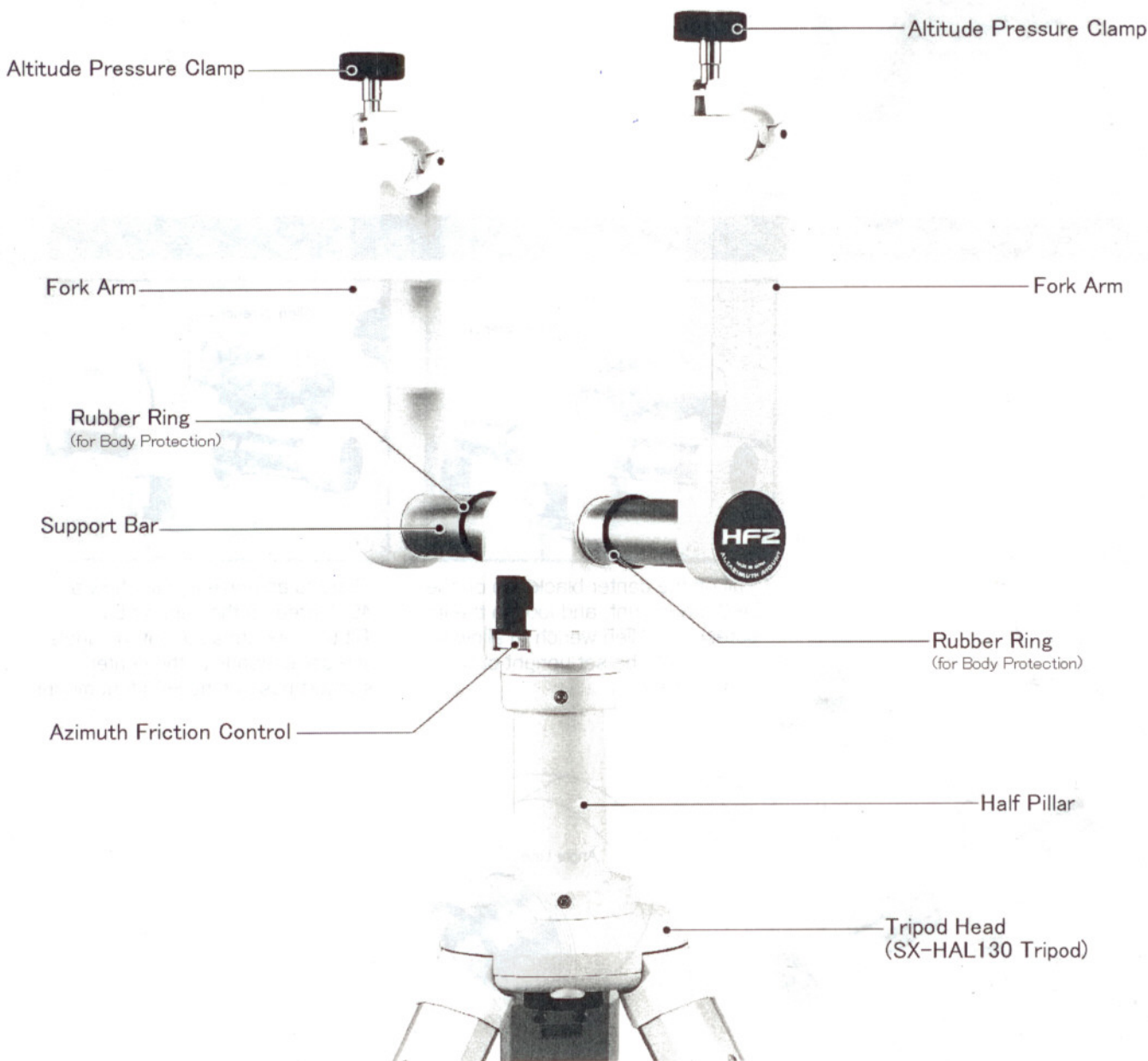

## SETTING UP THE FORK MOUNT

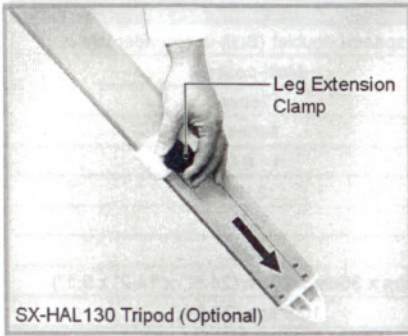

① Stand the tripod on an even and solid ground. Loosen the leg extension clamps and draw out the tripod legs.

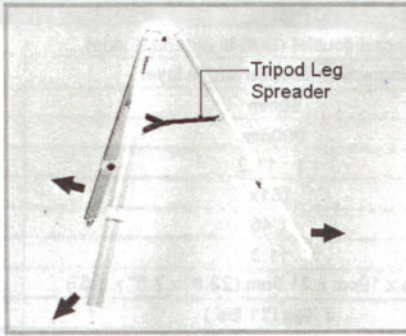

② Pull the legs apart until the tripod leg spreader has been fully extended to let the tripod stand by itself.

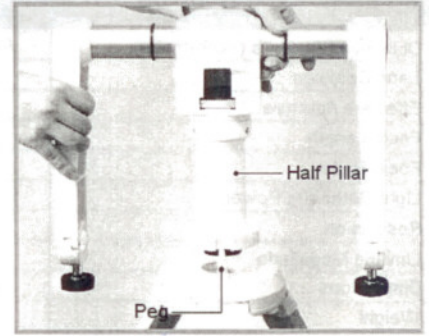

③ Attach the HF2 fork mount to the tripod head so that the hollow on the lower part of the half pillar is fit to the peg on the tripod head.

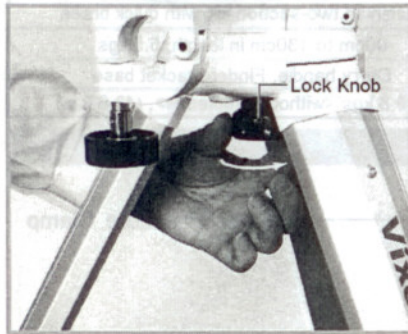

④ While holding the HF2 fork mount in one hand, tighten the lock knob beneath the tripod head securely.

## TILTING THE FORK ARMS

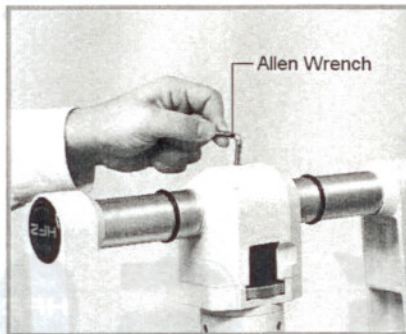

① Pull off the center black cap on the HF2 fork mount, and loosen the inner screw with Allen wrench to allow the fork arms to be set upright or 45-degree angle.

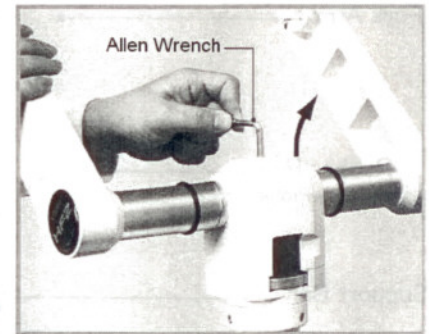

② There is an angle line to show a 45-degree on the support bar. Tilt the fork arms so that the angle line corresponds to the center support base of the HF2 fork mount.

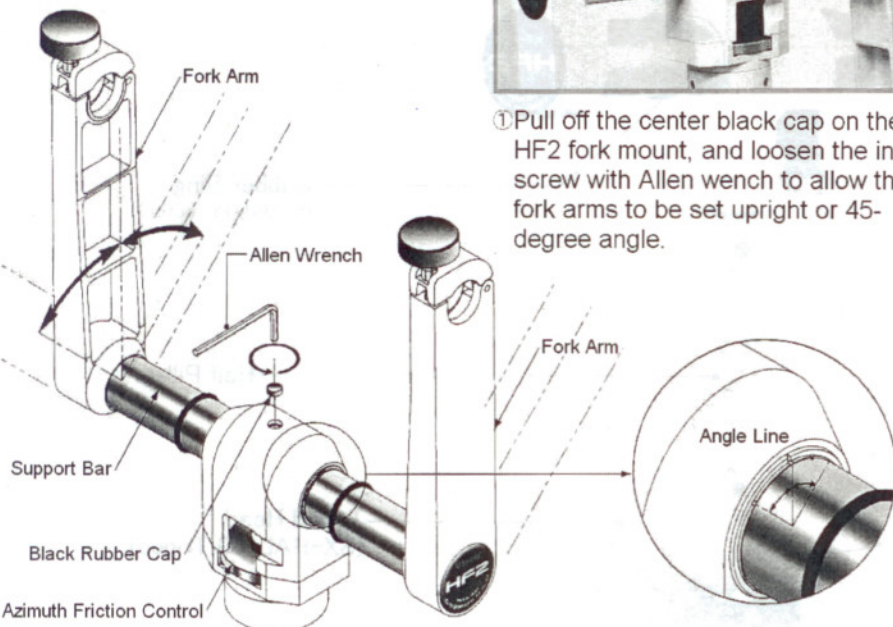

## MOUNTING A BT125-A BINOCULAR TELESCOPE

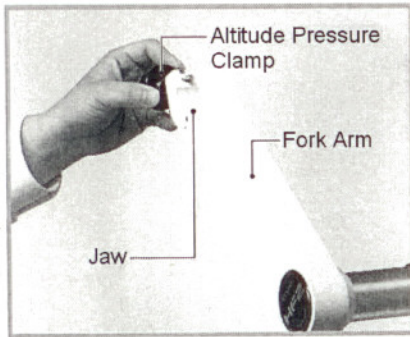

- ① Loosen the altitude pressure clamps and open the jaws of the upper side.

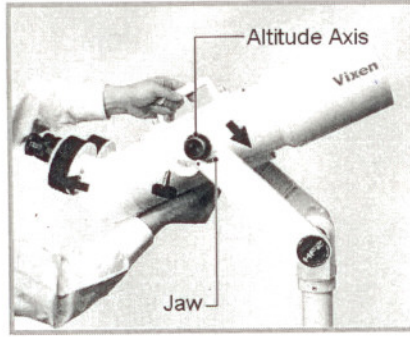

- ② Mount the BT125-A so that the two altitude axes on the binocular body are inserted in the lower jaws.

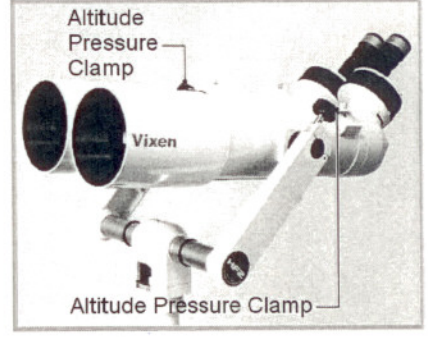

- ③ Cover the upper jaws and tighten the altitude pressure clamps slowly until the binocular balances itself by friction.

## MOUNTING A BT80-A BINOCULAR TELESCOPE

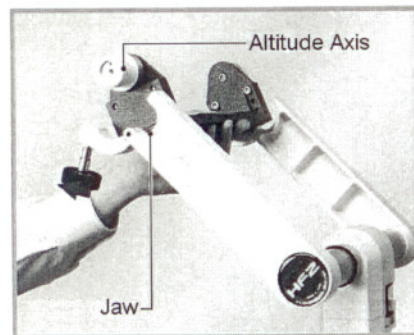

- ① Attach the swing bracket (optional) onto the lower jaws of the fork arms and cover the upper jaws. Tighten the altitude pressure clamps to hold it by friction.

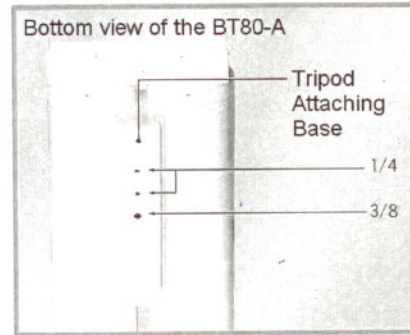

- ② Use one of the 1/4" screw holes on the bottom of the BT80-A to mount on the swing bracket.

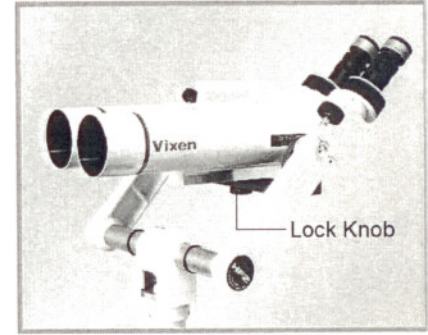

- ③ Tighten the lock knob firmly.

Both vertical and horizontal movements use friction to hold the mounted unit. Increase the tensions on the both axes as the need arises.

### Attaching a versatile Swing Bracket (sold separately) on the fork arms.

